

東芝照明器具配光データシート

名称	蛍光灯器具
形名	FHT-91185-P N9

保守率	良	0.73
	中	0.69
	否	0.61

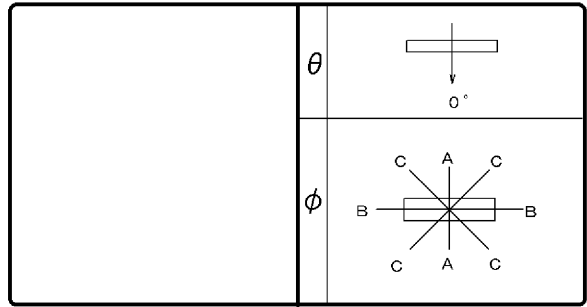

光源	名称	蛍光ランプ
	形名	FHF86EN/RX
	光束	9200 lm × 1

効率	F	1%
	F	88%
	F	89%
	器具光束	8138 lm

最大取付間隔	
A-A	1.4 H
B-B	1.3 H

備考	
----	--

前面	
反射面	塗装 (白)

光度 (cd/1000lm)			
$\theta \setminus \phi$	A-A	B-B	C-C
0°	233	233	233
10°	231	231	233
20°	231	221	228
30°	226	204	217
40°	215	179	203
50°	198	155	184
60°	169	117	158
70°	136	76	117
80°	76	38	71
90°	16	0	15
100°	0	0	0
110°	0	0	0
120°	0	0	0
130°	0	0	0
140°	0	0	0
150°	0	0	0
160°	0	0	0
170°	0	0	0
180°	0	0	0

反射率 (%)	天井		80				70				50				30		20		0	
	壁	床	70	50	30	70	50	30	50	30	50	30	50	30	30	10	0	0		
室指数	照明率 (×0.01)																			
0.60	52	47	38	36	30	29	50	46	38	36	30	29	36	35	29	29	29	28	24	22
0.80	62	56	49	46	40	38	60	55	48	45	39	38	46	43	38	37	37	37	32	30
1.00	69	62	55	51	46	44	66	60	54	50	46	43	52	49	44	43	43	42	37	35
1.25	76	67	63	58	54	50	73	66	61	57	53	50	58	55	51	49	49	48	43	41
1.50	80	71	68	62	59	55	77	69	66	61	58	54	63	59	56	53	54	52	48	46
2.00	88	77	77	69	69	63	85	75	75	68	68	62	71	66	65	61	62	60	56	54
2.50	93	80	83	73	75	68	89	78	81	72	74	67	76	70	70	66	67	64	61	58
3.00	96	82	88	77	80	72	92	81	85	76	78	71	80	73	75	69	71	68	64	62
4.00	101	85	94	81	88	77	97	84	91	80	85	76	85	78	81	74	76	73	70	68
5.00	103	87	97	84	92	80	99	86	94	82	89	79	88	80	84	77	80	76	73	71
10.00	109	91	106	89	103	87	105	90	102	88	99	86	95	86	93	84	87	83	81	79

