

東芝照明器具配光データシート

名称	蛍光灯器具
形名	FHT-93307-P N9

保守率	良	0.73
	中	0.69
	否	0.61

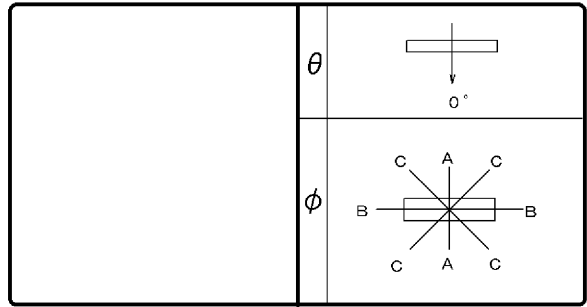

光源	名称	蛍光ランプ
	形名	FHF86EN/RX
	光束	9200 lm × 3

効率	F	17%
	F	72%
	F	89%
	器具光束	24692 lm

最大取付間隔	
A-A	1.5 H
B-B	1.3 H

備考	
----	--

前面	
反射面	塗装 (白)

光度 (cd/1000lm)			
$\theta \setminus \phi$	A-A	B-B	C-C
0°	171	171	171
10°	171	169	170
20°	170	163	167
30°	167	153	161
40°	163	137	153
50°	157	115	140
60°	135	86	126
70°	114	52	99
80°	106	20	82
90°	87	0	64
100°	65	0	44
110°	60	0	44
120°	58	0	34
130°	43	0	25
140°	29	0	14
150°	16	0	3
160°	4	0	0
170°	0	0	0
180°	0	0	0

反射率 (%)	天井		80				70				50				30		20	0		
	壁	床	70	50	30	10	70	50	30	10	70	50	30	10	50	30	30	10		
室指数	照明率 (×0.01)																			
0.60	49	45	36	34	28	27	46	43	34	33	27	26	32	30	25	25	23	23	19	16
0.80	59	53	45	42	37	35	56	51	43	41	35	34	40	38	33	32	31	30	25	22
1.00	65	58	52	48	43	40	61	56	49	46	41	39	45	43	38	37	35	34	29	26
1.25	72	64	59	54	50	47	68	61	56	52	48	45	51	48	44	42	41	40	34	31
1.50	76	67	64	58	55	51	72	64	61	56	53	49	55	52	48	46	45	43	38	34
2.00	84	73	73	65	64	58	79	70	69	63	61	57	62	58	56	53	51	49	44	40
2.50	88	76	78	69	70	63	83	73	74	66	67	61	67	62	61	57	56	53	48	44
3.00	91	78	82	72	75	67	86	75	78	70	71	65	70	65	65	60	59	56	52	47
4.00	96	82	88	76	82	72	90	78	84	74	78	70	75	69	70	65	64	61	56	52
5.00	99	83	92	79	86	75	93	80	87	76	82	73	78	71	74	68	67	64	59	55
10.00	105	88	101	85	97	83	99	85	95	82	92	80	85	77	82	75	74	70	66	61

